

The ISL8540 is a step down DC/DC power switching regulator which accepts a 9V to 40V input, and provides up to 2A of output current. The output voltage can be set between 1.21V and 35V by means of an external resistor divider. The device uses an internal power DMOS transistor with a typical $r_{DS(ON)}$ of 0.19Ω to obtain very high efficiency and high switching speed. A switching frequency in the range of 100kHz to 600kHz can be realized (the maximum power dissipation of the various packages must be observed). Notable features of this next generation DC/DC converter include pulse-by-pulse current limit for FET protection, hiccup-mode short circuit protection, voltage feedforward, frequency SYNC, soft-start, low standby current of 60 μ A typical in the disabled state and thermal shut-down. The device is available in a 20 Ld HTSSOP package.

Ordering Information

PART NUMBER (Note)	PART MARKING	TEMP. RANGE (°C)	PACKAGE (Pb-free)	PKG. DWG. #
ISL8540IVEZ	ISL85 40IVEZ	-40 to +85	20 Ld HTSSOP	MDP0048
ISL8540IVEZ-T*	ISL85 40IVEZ	-40 to +85	20 Ld HTSSOP	MDP0048
ISL8540EVAL1Z	Evaluation Board			

*Please refer to TB347 for details on reel specifications.

NOTE: These Intersil Pb-free plastic packaged products employ special Pb-free material sets; molding compounds/die attach materials and 100% matte tin plate PLUS ANNEAL - e3 termination finish, which is RoHS compliant and compatible with both SnPb and Pb-free soldering operations. Intersil Pb-free products are MSL classified at Pb-free peak reflow temperatures that meet or exceed the Pb-free requirements of IPC/JEDEC J STD-020.

Features

- Voltage feedforward
- Step down DC/DC supporting up to 2A
- Input voltage range of 9V to 40V
- Internal reference of 1.21V \pm 1%
- Adjustable output voltage range of 1.21V to 35V
- Adjustable switching frequency 100kHz to 600kHz
- Frequency SYNC pin
- Zero load current operation
- Pulse-by-pulse mode current limit
- Hiccup mode short-circuit protection
- Low standby current of 60 μ A typical
- Thermal shut-down
- Transient survival up at 60V for 400ms
- Pb-free (RoHS compliant)

Applications

- Industrial and automotive power supplies
- Portable computers
- Battery chargers
- Distributed power systems

Related Literature

- Technical Brief TB363 “Guidelines for Handling and Processing Moisture Sensitive Surface Mount Devices (SMDs)”

Pinouts

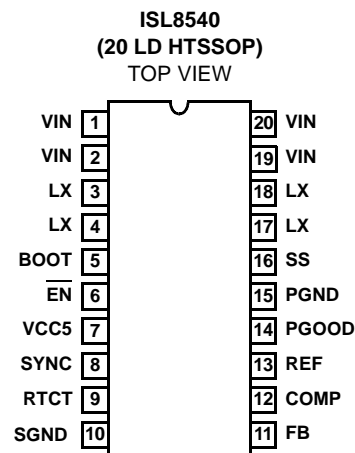

What's Inside

The Evaluation Board Kit contains the following materials:

- The ISL8540EVAL1Z REVB board.
- The ISL8540 datasheet.
- ISL8540 Evaluation Board Application Note.

Recommended Equipment

The following equipment is recommended to evaluate the performance of the board:

- 0V to 60V power supply with at least 5A current sourcing capability.
- Electronic Loads capable of sinking current up to 5A.
- Digital Multimeters (DMMs.)
- 100MHz quad-trace Oscilloscope.
- Signal generator (to test the SYNC feature only).

Quick Setup Guide

1. Ensure that the circuit is correctly connected to the supply and loads prior to applying any power.
2. Connect the bias supply to VIN, with the positive terminal connected to P1(VIN), and the return to P2(GND).
3. Connect the load across the output terminals, between pins P3 (positive) and P4 (return).
4. Verify that the jumper JP1 is connected.
5. Apply a voltage between 9V and 40V across the input.
6. Verify that the output voltage is 5V.

Evaluating the Other Output Voltage

The ISL8540EVAL1Z kit output is preset to 5V. The output voltage can be adjusted from 1.21V to 35V by Equation 1:

$$R_1 = (R_2) / ((V_{OUT} / V_{FB1}) - 1) \quad (\text{EQ. 1})$$

with $R_2 = 51.1\text{k}\Omega$ and $V_{FB1} = 1.21\text{V}$.

Note: The inductor, output capacitors and the compensation network may need to be tweaked, along with the corresponding compensation network, for optimal performance with change in output voltage and/or load. Also, additional heatsinking or airflow may required to insure that the junction temperature does not exceed +125°C.

Frequency

The ISL8540EVAL1Z kit is preset at 500kHz. The ISL8540EVAL1Z can be adjusted to operate at switching frequencies from 100kHz to 600kHz. Use C_{16} to program the switching frequency using Equation 2:

$$C_{16}[\text{nF}] = \frac{6.25}{R_7[\text{k}\Omega]} \left(\frac{1000}{f_{\text{OSC}}[\text{kHz}]} - 0.3 \right) \quad (\text{EQ. 2})$$

Synchronization

The ISL8540EVAL1Z circuit may be synchronized to a TTL signal that is set at a higher switching frequency than the pre-set frequency. The range of the external synchronizing frequency is from 100kHz to 600kHz. It is recommended to use and RTCT capacitor (C_{16}) of 2700pF in this configuration.

TABLE 1. SWITCH 1 SETTINGS

JP1	ENABLE	OPERATING MODE
1	OPEN	Unit Disabled
2	GND	Unit Enabled

Schematic

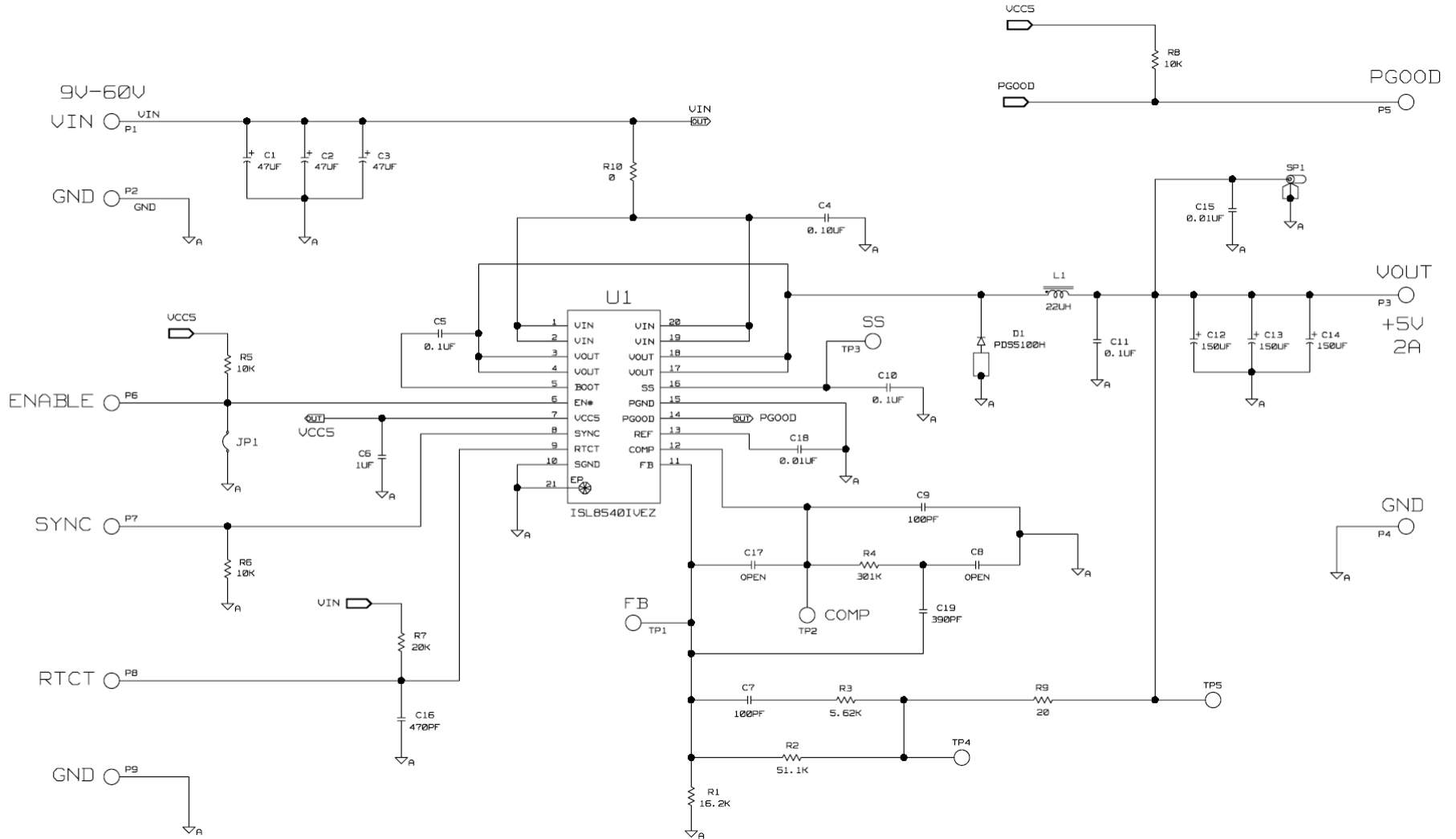

Application Note 1323

TABLE 2. COMPONENT LIST

REF DES	QTY	VALUE	TOL.	VOLTAGE	PACKAGE	PART NUMBER	MANUFACTURER	DESCRIPTION
C5, C10, C11	3	0.10 μ F	10%	50V	0603	C1608X7R1H104K-T	TDK	CAPACITOR, SMD, 0603, 0.10 μ F, 50V, 10%, X7R
C12-C14	3	150 μ F	20%	25V	8mmx10mm	EEE-FK1E151P-T	PANASONIC	CAP. SMD, 1.0.3mm, 150 μ F, 25V, 20%, ROHS, ALUM. ELEC.
C1-C3	3	47 μ F	20	100V	12.5mmx13.5mm	EEV-FK2A470Q-T	PANASONIC	CAPACITOR, SMD, H13, 47 μ F, 100V, 20%, ROHS, ALUM. ELEC.
C7, C9	2	100pF	5%	50V	0603	H1045-00101-50V5-T	AVX, Samsung, TDK, Murata, Vishay	CAPACITOR, SMD, 0603, 100pF, 50V, 5%, NPO, ROHS
C15	1	0.01 μ F	10%	50V	0603	H1045-00103-50V10-T	AVX, Samsung, TDK, Murata, Vishay	CAPACITOR, SMD, 0603, 0.01 μ F, 50V, 10%, X7R, ROHS
C18	1	1 μ F	10%	16V	0603	H1045-00105-16V10-T	AVX, Samsung, TDK, Murata, Vishay	CAPACITOR, SMD, 0603, 1 μ F, 16V, 10%, X7R, ROHS
C19	1	390pF	5%	50V	0603	H1045-00391-50V5-T	AVX, Samsung, TDK, Murata, Vishay	CAPACITOR, SMD, 0603, 390pF, 50V, 5%, NPO, ROHS
C8, C17	0	OPEN	-	-	-	H1045-DNP	AVX, Samsung, TDK, Murata, Vishay	CAPACITOR, SMD, 0603, DNP-PLACE HOLDER, ROHS
C6	1	1.0 μ F	10%	25V	0805	H1046-00105-25V10-T	AVX, Samsung, TDK, Murata, Vishay	CAPACITOR, SMD, 0805, 1.0 μ F, 25V, 10%, X7R, ROHS
C4	1	0.1 μ F	10%	100V	1206	H1065-00104-100V10-T	AVX, Samsung, TDK, Murata, Vishay	CAPACITOR, SMD, 1206, 0.1 μ F, 100V, 10%, X7R, ROHS
C16	1	470pF	5%	100V	1206	H1065-00471-100V5-T	AVX, Samsung, TDK, Murata, Vishay	CAPACITOR, SMD, 1206, 470pF, 100V, 5%, NPO, ROHS
L1	1	22 μ H	20%	-	18mmx15mm	DO5010H-223MLB	COILCRAFT	COIL-PWR INDUCTOR, SMD, 18x15, 22 μ H, 20%, 7A, ROHS, 47m Ω
JP1	1	0 Ω	-	-	Header	SPC02SYAN	SULLINS	CONN-JUMPER, 2 PIN, SHUNT, ROHS
D1	1	5A	-	100V	Power DI-5	PDS5100H	DIODES INC.	DIODE-RECTIFIER, SMD, Power DI-5, 100V, 5A, ROHS, SCHOTTKY
U1	1	2A	-	40V	20 HTSSOP	ISL8540IEVZ	INTERSIL	IC-STEP DOWN DC/DC CONVERTER, 20P, HTSSOP, ROHS
R9	1	20 Ω	1%	100V	0603	H2511-0200-1/10W1-T	PANASONIC	RESISTOR, SMD, 0603, 20 Ω , 1/10W, 1%, TF, ROHS
R5, R6, R8	3	10k	1%	100V	0603	H2511-1002-1/16W1-T	PANASONIC	RESISTOR, SMD, 0603, 10k, 1/16W, 1%, TF, ROHS
R1	1	16.2k	1%	100V	0603	H2511-1622-1/16W1-T	PANASONIC	RESISTOR, SMD, 0603, 16.2k, 1/16W, 1%, TF, ROHS
R4	1	301k	1%	100V	0603	H2511-3013-1/10W1-T	YAGEO	RESISTOR, SMD, 0603, 301k, 1/10W, 1%, TF, ROHS
R2	1	51.1k	1%	100V	0603	H2511-05112-1/16W1-T	PANASONIC	RESISTOR, SMD, 0603, 51.1k, 1/16W, 1%, TF, ROHS
R3	1	5.62k	1%	100V	0603	H2511-5621-1/16W1-T	PANASONIC	RESISTOR, SMD, 0603, 5.62k, 1/16W, 1%, TF, ROHS
R7	1	20k	1%	100V	0603	H2513-02002-1/4W1-T	PANASONIC	RESISTOR, SMD, 1206, 20k, 1/4W, 1%, TF, ROHS
R10	1	0 Ω	1%	100V	0603	H2515-00R00-1W-T	VENKEL	RESISTOR, SMD, 2512, 0 Ω , 1W, TF, ROHS

ISL8540EVAL1Z Board Layout

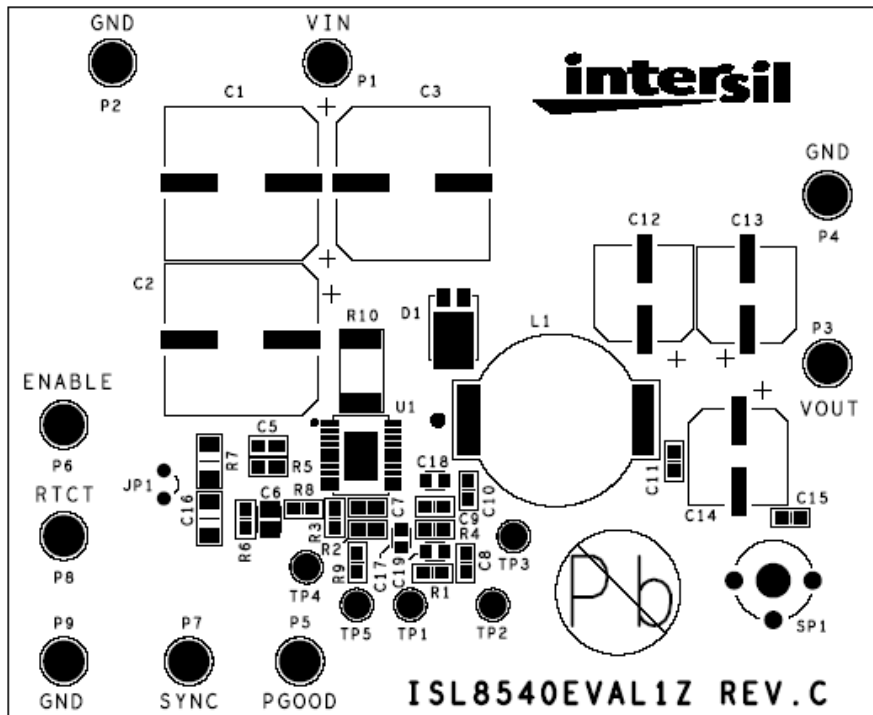

FIGURE 1. TOP COMPONENTS

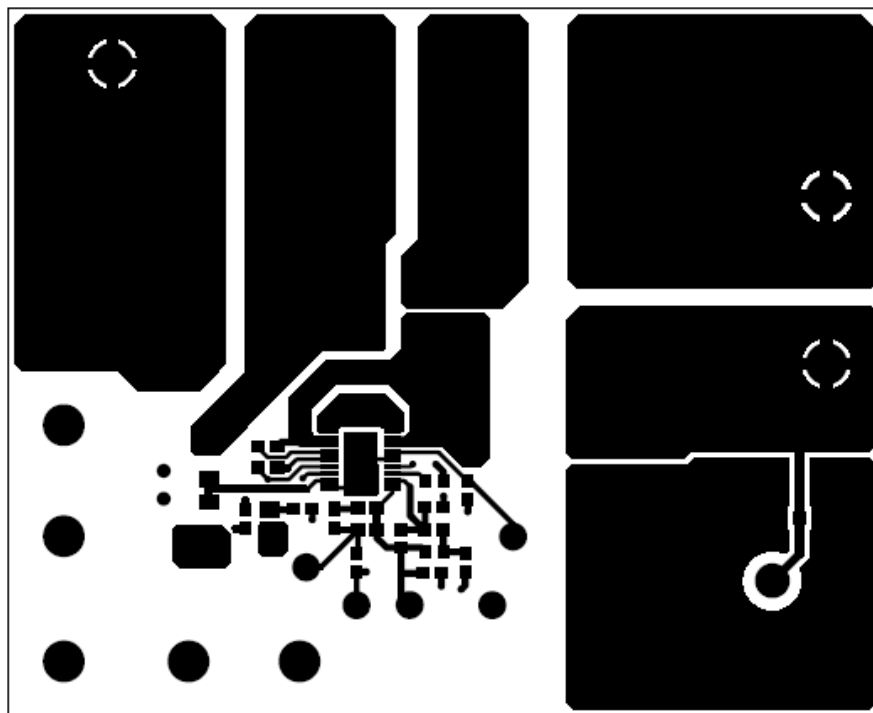

FIGURE 2. TOP LAYER ETCH

ISL8540EVAL1Z Board Layout (Continued)

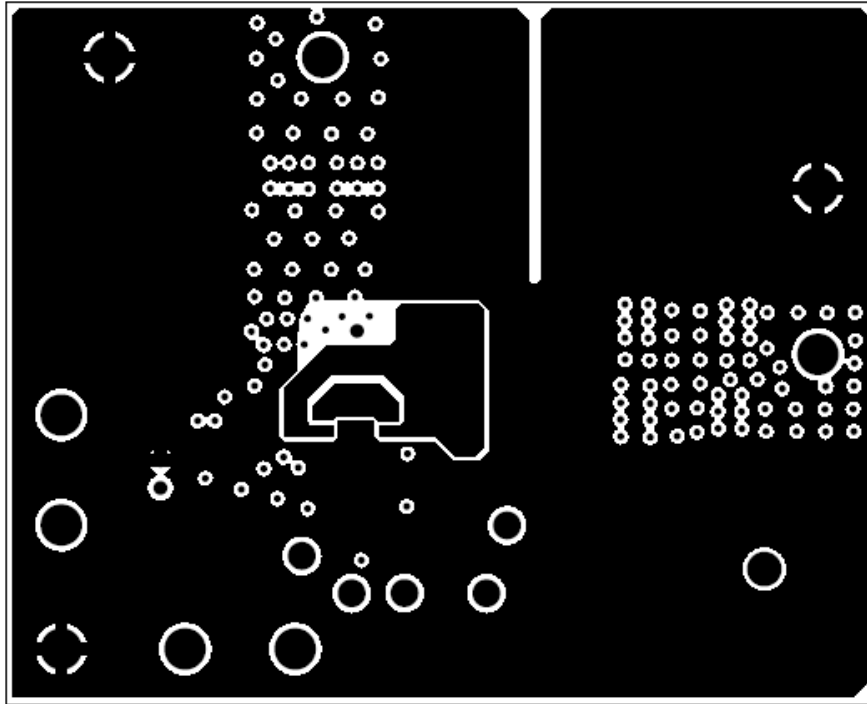

FIGURE 3. 2ND LAYER ETCH

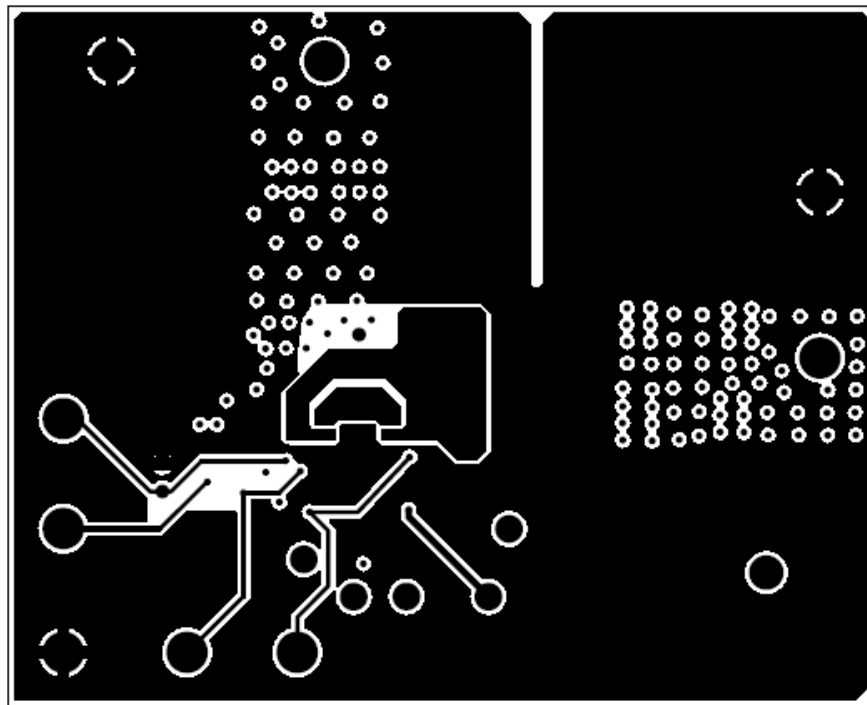

FIGURE 4. 3RD LAYER ETCH

ISL8540EVAL1Z Board Layout (Continued)

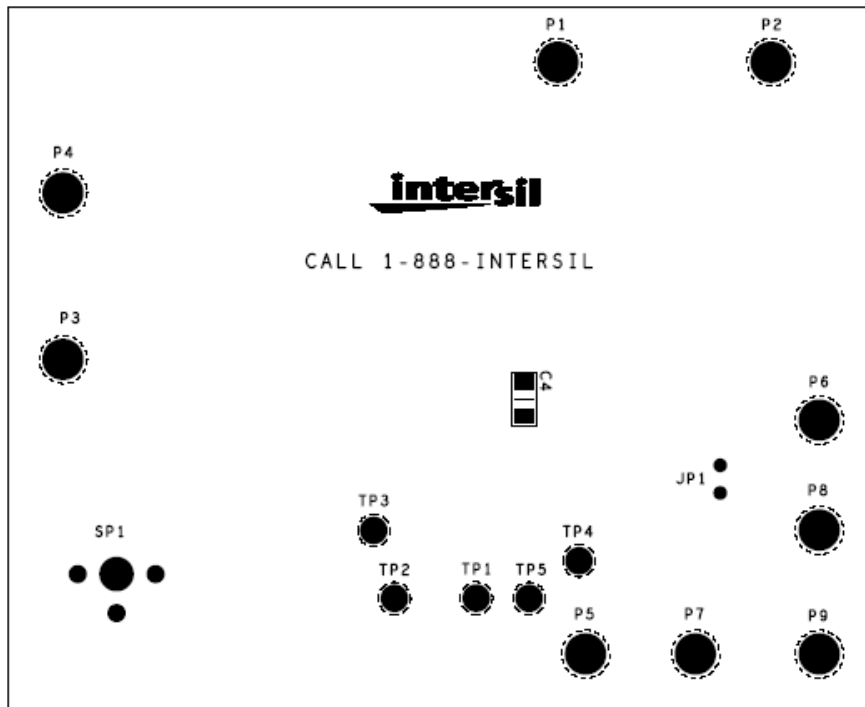

FIGURE 5. BOTTOM LAYER COMPONENTS (MIRRORED)

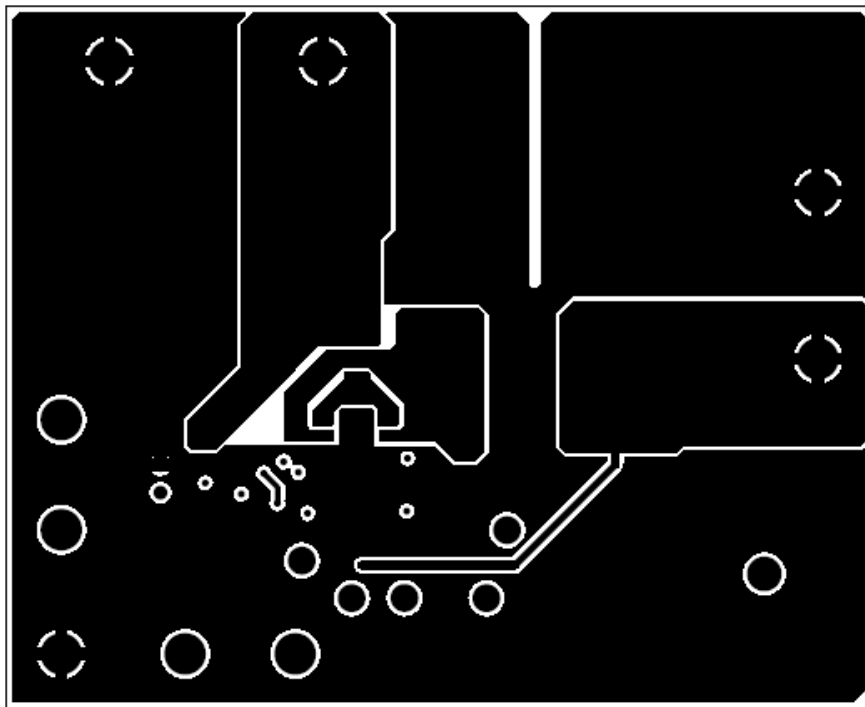

FIGURE 6. BOTTOM LAYER ETCH (MIRRORED)

Intersil Corporation reserves the right to make changes in circuit design, software and/or specifications at any time without notice. Accordingly, the reader is cautioned to verify that the Application Note or Technical Brief is current before proceeding.

For information regarding Intersil Corporation and its products, see www.intersil.com